



Product Catalog



A photograph of a man and a woman sitting at a dining table. The man is pouring wine from a green bottle into a glass held by the woman. They are both smiling. The table is set with white dishes, glasses of wine, and a green napkin. The background is a bright, outdoor setting with greenery.

Reimagining The Way We Live



Table of Contents

	SPECIFICATIONS	5
	DOOR STYLES	10
	FINISHES	23
	GRILL BASE CABINETS	27
	CERAMIC GRILL CABINETS	33
	BASE CABINETS	37
	WALL CABINETS	47
	TALL CABINETS	50
	PANELS, FILLERS & ACCESSORIES	52
	WINDSWEPT MOLDINGS	67
	HOODS	73





Specifications

Windswept Collection / Storm

Cabinet Construction Specifications

CABINET BOX

Cabinet sides, top and bottom are constructed with a 3/4" thick, lightweight HDPE (HDPE) poly marine board that is UV stable. It is NOT PVC.

All of the components are assembled with hidden polymer. These fasteners are made from high strength plastic and CNC machined into the cabinet parts.

EDGEBANDING

There is no edgelanding, the HDPE is solid black and all cabinet edges are black. The full overlay door covers all but 1/8" of the edge. This also eliminates possible edgelanding point of failure.

CABINET BACK

All cabinets have a 1/4" thick (HDPE) back with 4" nailers top and bottom.

SHELVES

Shelves are 3/4" thick HDPE. There are shelf holes drilled in 32mm (1 1/4") increments. All shelves are full depth. Shelves over 28" wide will have lineal support front and back.

DRAWER BOXES

Standard drawer boxes are constructed with 3/4" HDPE sides and back with a 1/4" thick bottom and assembled with panel connector. Full extension soft-close bottom mount slides are treated for corrosion.

DOOR HINGES

Hinges are soft-close stainless steel 110° concealed hinges with 6 way adjustment.

FINISHED ENDS

Finished ends can be purchased loose. Finished end panels are the thickness of the species panel, which adds to the overall width of a cabinet.

TOE KICK

All base and tall cabinets are constructed on adjustable leg levelers. 3 1/2" to 5" high. Additional height levelers and spacers available.



Cabinet Standards

GENERAL SPECIFICATIONS

We manufacture our cabinet boxes using 3/4" Black HDPE (Low Density Polyurethane). HDPE is UV stable.

CABINET SIZES

Available in sizes listed only. To change the depth of a cabinet to 24" or 28", modification charges will apply. See modification section for up-charges. Modifications limited to the nearest inch.

MINIMUM CABINET WIDTH

With doors: 9" W based on the minimum width of available door styles. With drawers: 12" W

MAXIMUM CABINET WIDTH

To be warrantied, the maximum width of a specific cabinet type is the width listed as the largest available.

MINIMUM HEIGHT

With doors: 12" H

MAXIMUM HEIGHT

90 1/2"

STANDARD CABINET DEPTHS *(Defaults)*

Wall cabinets: 13" D
Base cabinets: 24" or 28" D
Grill base cabinets: 28" D
Burner base cabinets: 28" D
Wall depth base cabinets: 13" D
Base depth tall cabinets: 24" D

MAXIMUM DEPTH

36" D. When the depth is increased for cabinets with drawers and/or roll out drawers, the drawer box depth remains 21" regardless of cabinet depth.

FINISHED ENDS

ZähBuilt provides finished ends as an applied panel, subject to additional up-charges. Integrated finished end available in Sonoma collection per request.

TOE KICK

ZähBuilt provides plastic leg levelers that are adjustable from 3 1/2" H to 4-1/2" H. We also offer door matching toe kick planks



General Knowledge

GENERAL INSTALLATION GUIDELINES

- It is very important the cabinetry is installed level and plumb. This will ensure the doors hang properly. The fronts are set squarely at the factory. If the cabinet is not level, the doors are drawers will be skewed. Only after leveling should the doors be adjusted.
- To adjust the floor levelers, we recommend the use of the Hafele leveler tool (PN # 637.76.430) for easy access, available from ZähBuilt or Hafele direct.
- Use stainless steel screws and washers for installation hardware.
- Grill panels may be removed in order to trim and fit to the grill. The countertop thickness will determine the depth of the cut. Reattach the trimmed grill panel using button fix.
- The door adjustments are accessible by removing the cover plate on the hinge arm.
- There is a small amount of adjustment available on the drawer by using the dials on the drawer box clips.

CABINETS AND PARTS

- The HDPE cabinet parts saw and machines similar to MDF with smooth, non-splintered, chip free cuts.
- Cleans with soap and water. Use denatured alcohol or non oil based cleaners for greasy spots.
- All cabinet backs are 1/4" HDPE with 4" nailers top and bottom.
- We recommend 1-1/4" stainless steel washer head screws for joining cabinets and fillers, etc.
- Bases come with adjustable leg levelers, making installation easy on sloped floors.
- The toe plates are held in place with a friction clip on the leveler, additional screws could be used as necessary.

GRILL ACCOMMODATIONS

- An insulation jacket is required for gas grill cabinets.
- The cabinet needs to be minimum 3" wider than grill insulation jacket, preferably 6" + (must be 6" wider for NEO collection).

Working With Our Sonoma HPL Panels

SAWING

- Sonoma panels can be cut on stationary circular saws, portable circular saws or jig saws using carbide tipped blades.
- We recommend alternating bevel fine cutting blades.
- Cutting too fast or too slow can result in surface discoloration. The discolored surface can be sanded off using 180 - 220 grit sandpaper.

FINISHING

- Cut edges are dangerously sharp and need to be eased. We recommend routing the edges or breaking the edge with sand paper.
- Teak or mineral oil can be used to polish the edges and add a layer of protection.

DRILLING

- Use high-speed steel drill bits.

ATTACHING

- Stainless steel screws offer the most secure way of attaching Sonoma panels/fillers/overlay doors to our cabinetry.
- Carefully drill a pilot hole first. Stainless steel self tapping screws are a good option as Sonoma panels produce a fine thread and can be tapped.
- VHB tape is a good alternative for panels resting on a solid surface or to hold panels until the adhesive sets.





Door Styles

Windswept Cumulus / Louver Door

Specifications

COLLECTION

Windswept

CONSTRUCTION

1" thick Stiles & Rails, 5/8" Panel

RAIL WIDTH

2 3/4"

MINIMUM/MAXIMUM

DOOR WIDTH

12" / 24"

MINIMUM/MAXIMUM

DOOR HEIGHT

12" / 60"

DRAWER FRONTS

The top drawer face is always a 7" high slab drawer fronts over 8" can be ordered in a stile and rail configuration for an additional cost

FINISHED BACK OF DOOR

Painted Base Color only, no glaze

EDGE PROFILES



Finish / Sand

The center louver is accomplished by stacking 6" wide T & G moldings. The moldings "float" between the stiles and rails utilizing our patent design. This method of assembly mitigates movement that may split the frame or damage the paint.

Windswept Virga / Shaker Door

Specifications

COLLECTION

Windswept

CONSTRUCTION

1" thick Stiles & Rails, 5/8" Panel

RAIL WIDTH

2 3/4"

MINIMUM/MAXIMUM

DOOR WIDTH

12" / 24"

MINIMUM/MAXIMUM

DOOR HEIGHT

12" / 60"

DRAWER FRONTS

The top drawer face is always a 7" high SLAB.drawer fronts over 8" can be ordered in a stile and rail configuration for an additional cost

FINISHED BACK OF DOOR

Painted Base Color only, no glaze

The center panel is "floating" between the stiles and rails utilizing our patent design. This method of assembly mitigates movement that may split the frame or damage the paint.

EDGE PROFILES



Finish / Storm

Windswept Anvil / Slab Door

Specifications

COLLECTION
Windswept

CONSTRUCTION
Slab

**MINIMUM/MAXIMUM
DOOR WIDTH**
12" - 24"

**MINIMUM/MAXIMUM
DOOR HEIGHT**
12" / 60"

DRAWER FRONTS
1" thick slab with integral edge detail

GRAIN DIRECTION, DOOR
Grain direction is vertical on doors,
horizontal grain not available

GRAIN DIRECTION, DRAWER
Grain direction is horizontal on
drawers, vertical grain not available

FINISHED BACK OF DOOR
Painted base color only, no glaze

EDGE PROFILES



Finish / Cyclone

Windswept Cirrus / Skinny Shaker Door

Specifications

COLLECTION

Windswept

CONSTRUCTION

Accoya trim with an eased edge wrapping a veneered composite panel

MINIMUM/MAXIMUM

DOOR WIDTH

9" / 21"

MINIMUM/MAXIMUM

DOOR HEIGHT

12" / 60"

DRAWER FRONTS

Match door construction

GRAIN DIRECTION, DOOR

Grain direction is vertical by default.

GRAIN DIRECTION, DRAWER

Grain direction is horizontal by default.

FINISHED BACK OF DOOR

Same finish as the front

DOOR STYLE FACTOR

Factor is 10% and upgrade

Cirrus

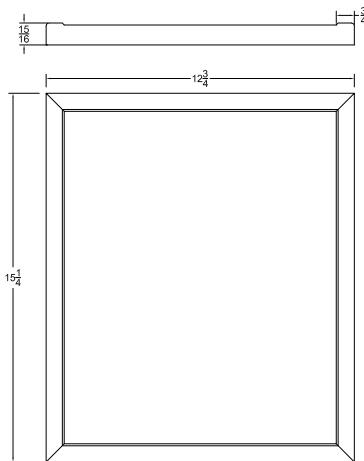

Finish / Wheatland

Windswept Alto / Mitered Bolection

Specifications

COLLECTION

Windswept

CONSTRUCTION

1" thick Stiles & Rails, 5/8" Panel

RAIL WIDTH

2 3/4"

MINIMUM/MAXIMUM

DOOR WIDTH

12" / 24"

MINIMUM/MAXIMUM

DOOR HEIGHT

12" / 60"

DRAWER FRONTS

The top drawer face is always a 7" high SLAB.drawer fronts over 8" can be ordered in a stile and rail configuration for an additional cost

FINISHED BACK OF DOOR

Painted Base Color only, no glaze

EDGE PROFILES



Finish / Paracas

The center panel is "floating" between the stiles and rails utilizing our patent design. This method of assembly mitigates movement that may split the frame or damage the paint.

Windswept Aurora / Mitered Shaker

Specifications

COLLECTION

Windswept

CONSTRUCTION

1" thick Stiles & Rails, 5/8" Panel

RAIL WIDTH

2 3/4"

MINIMUM/MAXIMUM

DOOR WIDTH

12" / 24"

MINIMUM/MAXIMUM

DOOR HEIGHT

12" / 60"

DRAWER FRONTS

The top drawer face is always a 7" high SLAB.drawer fronts over 8" can be ordered in a stile and rail configuration for an additional cost

FINISHED BACK OF DOOR

Painted Base Color only, no glaze

The center panel is "floating" between the stiles and rails utilizing our patent design. This method of assembly mitigates movement that may split the frame or damage the paint.

EDGE PROFILES



Finish / Riptide Blue

Windswept Ripcurl / J-Pull

Specifications

COLLECTION

Windswept

CONSTRUCTION

Slab with 1-1/16" sloped edge

MINIMUM/MAXIMUM

DOOR WIDTH

9" / 21"

MINIMUM/MAXIMUM

DOOR HEIGHT

12" / 60"

DRAWER FRONTS

Match door construction

GRAIN DIRECTION, DOOR

Grain direction is vertical by default.

GRAIN DIRECTION, DRAWER

Grain direction is horizontal by default.

FINISHED BACK OF DOOR

Same finish as the front

DOOR STYLE FACTOR

Factor is 10%



Finish / Overcast

Sonoma Slab Door

Specifications

COLLECTION

Sonoma

CONSTRUCTION

5/8" Sonoma (phenolic resin) door with micro chamfer with an ebony colored polished edge

MINIMUM/MAXIMUM

DOOR WIDTH

9" / 21"

MINIMUM/MAXIMUM

DOOR HEIGHT

12" / 60"

DRAWER FRONTS

5/8" thick slab with micro chamfer edges

GRAIN DIRECTION, DOOR

Grain direction is vertical by default.

GRAIN DIRECTION, DRAWER

Grain direction is horizontal by default.

FINISHED BACK OF DOOR

Same finish as the front

DOOR STYLE FACTOR

Also applies to all panels and fillers

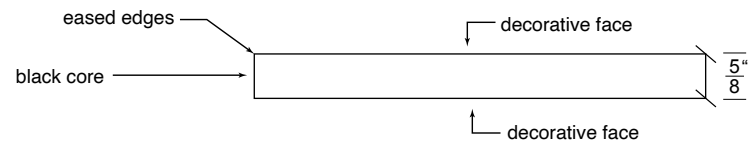

Finish / Royal Walnut

*Sonoma Door / Drawer specifications continue on to the next page.

Neo Door

Specifications

AVAILABLE

Brushed Aluminum finish or powder coated black available

CONSTRUCTION

Aluminum with either a 1/4" thick Sonoma or 3/4" thick Accoya insert

MINIMUM/MAXIMUM

DOOR WIDTH

12" / 24"

MINIMUM/MAXIMUM

DOOR HEIGHT

12" / 60"

GRAIN DIRECTION, DOOR

Grain direction is vertical on door panel

GRAIN DIRECTION, DRAWER

Grain direction is horizontal on drawers, vertical grain not available

Top drawer is always 7" high

FINISHED OPTIONS

Neo doors are available with all Windswept and Sonoma color selections

FINISHED BACK OF DOOR

Windswept back will be base color only, Sonoma will be same as face

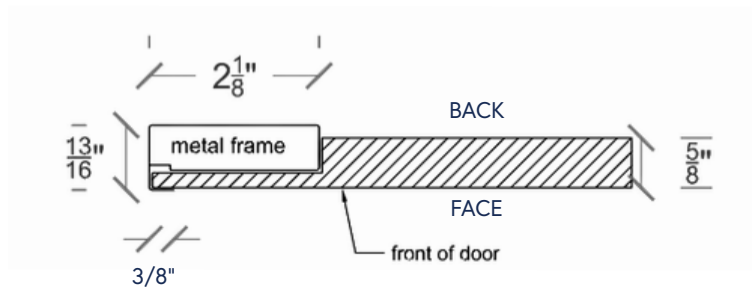

*Sonoma Door / Drawer specifications continue on to the next page.

Additional Neo Information

CROSS SECTION

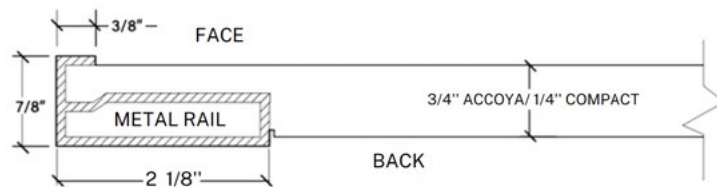

NEO GRILL FRONTS

NEO Grill fronts will only have the Aluminum frame on the bottom and 2 sides to make it easier to install the insulated jacket.

Grill Cabinet must be a minimum of 6" wider than the Insulated Jacket.

Opus/Slab Door *COMING SOON*

Specifications

COLLECTION
Opus

CONSTRUCTION
3/4" One piece Composite Board
WITH Eased EDGE

**MINIMUM/MAXIMUM
DOOR WIDTH**
9"/24"

**MINIMUM/MAXIMUM
DOOR HEIGHT**
12"/60"

DRAWER FRONTS
3/4" One piece Composite Board
WITH Eased EDGE

GRAIN DIRECTION
Solid no grain Direction

DESIGN CONSIDERATIONS
Doors painted solid color front and
back. Only solid colors are available in
this collection, with no glazed finishes.

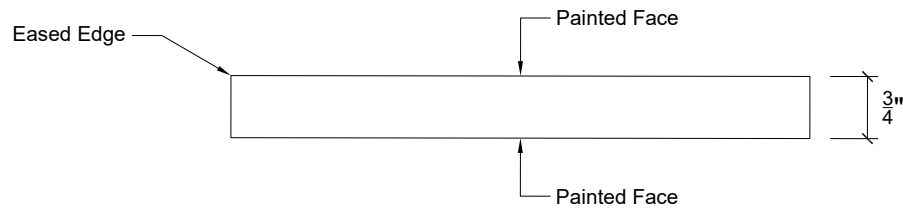

Opus/Shaker Door COMING SOON

Specifications

COLLECTION

Opus

CONSTRUCTION

3/4" One piece Composite Board
1/4" Routed Center with
1/4" Beveled inside
profile and eased EDGE

MINIMUM/MAXIMUM

DOOR WIDTH

9"/24"

MINIMUM/MAXIMUM

DOOR HEIGHT

12"/60"

DRAWER FRONTS

3/4" One piece Composite Board
WITH Eased EDGE

GRAIN DIRECTION

Solid no grain Direction

DESIGN CONSIDERATIONS

Doors painted solid color front and
back. Only solid colors are available in
this collection, with no glazed finishes.

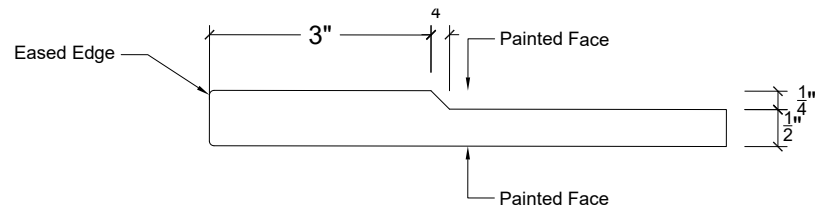



Finishes

Sonoma Collection / Noce Havana

Sonoma Finishes

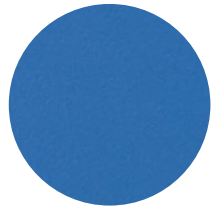

Spa



Sea White



Avalon Oak

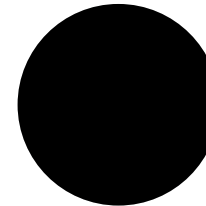

Cinder



Grey Cedar



Noce Havana

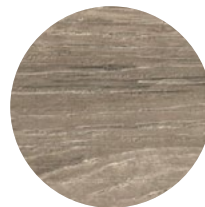

Riverside Oak



Royal Walnut



Polar White

HOW IT'S MADE

Layers of sustainability harvested kraft paper are impregnated with thermosetting phenolic resins. The surface decorative finish layers are then applied on both sides and a transparent topcoat is added to the surface layers. This is cured to enhance weather and light protecting properties. The panels are then subject to high heat and pressure to bond the material into a non-porous, homogeneous material that is dense and perfect for outdoor surfaces like our cabinetry.

DESIGN CONSIDERATIONS

Sonoma doors, drawers and panels are available in a sleek, ebony-polished edge, offering a clean, contemporary look. ZähBuilt has proprietary 5/8" (16mm) thick

Windswept Door Finishes



Cyclone



Seaside



Sand



Sahara



Cocoa Bean



Wave Crest



Storm



Riptide Blue



Wheatland



Tempest

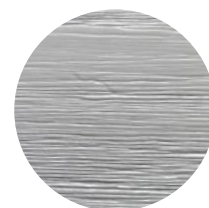

Overcast

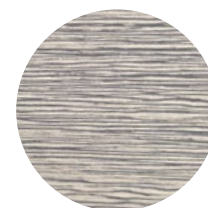

Tephra



Paracas

DESIGN CONSIDERATIONS

Doors painted in White will come standard with a white door back, all other paint colors, stain and glaze or weathered finishes come standard with base color back, regardless of cabinet interior color.

Custom Color Options

Windswept Custom Color Program



DESIGN CONSIDERATIONS

- Only available in solid colors, no glazes
- Standard selection of solid paint colors
- \$250 NET sample cost for approval is mandatory
- Add 2 weeks to lead time
- Approximate 10% cost increase over standard
- Windswept door cost

Sonoma Custom Color Program



DESIGN CONSIDERATIONS

- Ask your sales rep for current selections and lead time
- Add 8-12 weeks to lead time
- \$2,500 NET cost for custom color
- Approximate 15% cost increase over Sonoma door cost

321-308-3297 SALES@ZAHBUILT.COM ZAHBUILT.COM



Grill Base Cabinets

Windswept Collection / Cyclone



Grill Base Specifications

- Grill/side burner bases are available from 18" to 78" wide constructed from 3/4" black HDPE and assembled with dowels and strategic stainless steel screws
- Grill bases are 30 1/2" tall with 4" adjustable plastic leveler legs
- Grill bases have removable/trimmable "L" shaped risers to support the grill Insulated Jacket
- Grill base must be a minimum 3" wider than grill Insulated Jacket, preferably 6" + (must be 6" wider for NEO collection)
- Grill bases are 28" deep as a standard with ventilation grills in decks of cabinet.



HDPE risers are trimmed on site to provide the proper grill height. The stretcher and riser system allows air flow for proper ventilation. Place risers near to/above the partitions.

- All grills require an insulation jacket, generally this requires a base cabinet at least 6" wider than the grill
- All grill bases have a 12 1/2" high front that needs to be cut to accommodate the liner dimensions, the final height is determined by the countertop thickness (grill height minus countertop thickness = front cut out)
- Standard propane tanks will slide under the grill due to our patent pending aluminum drop down tray, this tray also provides a gas ventilation
- Cabinet edges are black



Optional Ventilation/propane tank clearance trays are installed into the bottom of all grill base and burner base cabinets in order to prevent potential gas build-up within the cabinets (Patent Pending).

Standard Grill Base Cabinets

All Grill Base Cabinets available in 24" depth

2-DOOR



SKU

- GB30-2
- GB36-2
- GB39-2
- GB42-2

DESIGN CONSIDERATIONS

- Cabinet is 28" DEEP
- Front panel is 12 1/2" H
- Panel can be cut on site to fit individual grills
- Doors are 17 3/4" H

PARTITION

- Cabinets 36" W and wider will have a centered vertical partition between the doors

3-DOORS



SKU

- GB45-3
- GB48-3
- GB54-3
- GB60-3

DESIGN CONSIDERATIONS

- Cabinet is 28" DEEP
- Front panel is 12 1/2" H
- Panel can be cut on site to fit individual grills
- Doors are 17 3/4" H

PARTITION

- Cabinets 36" W and wider will have a centered vertical partition between the doors

4-DOORS



SKU

- GB45-4
- GB48-4
- GB54-4
- GB60-4
- GB72-4
- GB78-4

DESIGN CONSIDERATIONS

- Cabinet is 28" DEEP
- Front panel is 11 7/8" H
- Panel can be cut on site to fit individual grills
- Doors are 17 3/4" H

PARTITION

- Cabinets will have a partition separating the doors

XL Grill/Pellet Grill Base Cabinets

2-DOOR



SKU

- XLGB30-2
- XLGB36-2
- XLGB39-2
- XLGB42-2

DESIGN CONSIDERATIONS

- Cabinet is 28" DEEP
- Front panel is 18" H
- Panel can be cut on site to fit individual grills
- Doors are 12 1/4" H

PARTITION

- Cabinets 36" W and wider will have a centered vertical partition between the doors

3-DOORS



SKU

- XLGB45-3
- XLGB48-3
- XLGB54-3
- XLGB60-3

DESIGN CONSIDERATIONS

- Cabinet is 28" DEEP
- Front panel is 18" H
- Panel can be cut on site to fit individual grills
- Doors are 12 1/4" H

PARTITION

- Cabinets 36" W and wider will have a centered vertical partition between the doors

4-DOORS



SKU

- XLGB45-4
- XLGB48-4
- XLGB54-4
- XLGB60-4
- XLGB72-4
- XLGB78-4

DESIGN CONSIDERATIONS

- Cabinet is 28" DEEP
- Front panel is 18" H
- Panel can be cut on site to fit individual grills
- Doors are 12 1/4" H

PARTITION

- Cabinets will have a partition separating the doors

Standard Grill Base Cabinets

4 DRAWERS



SKU

- GB30-4D GB54-4D
- GB36-4D GB60-4D
- GB39-4D GB72-4D
- GB42-4D GB78-4D
- GB45-4D
- GB48-4D

DESIGN CONSIDERATIONS

- Grill base is 28" deep
- Front panel is 12 1/2" high to be cut by installer
- Drawer fronts are 8 3/4" high
- Drawer fronts over 8" can be ordered in a stile and rail configuration for an additional cost

PARTITION

- There is a full depth partition separating the drawers

2 DRAWERS & 1 DOOR



SKU

- GBC30-(L,R) GBC30-(L,R)
- GBC36-(L,R) GBC36-(L,R)
- GBC39-(L,R) GBC39-(L,R)
- GBC42-(L,R) GBC42-(L,R)

DESIGN CONSIDERATIONS

- Grill base is 28" deep
- Front panel is 12 1/2" high to be cut by installer
- Drawer fronts are 8 3/4" high
- Drawer fronts over 8" can be ordered in a stile and rail configuration for an additional cost

PARTITION

- There is a full depth partition separating the drawers
- The 'R' or 'L' signify what side the drawers are on

2 DRAWERS & 2 DOOR



SKU

- GBC48 (L,R) GBC54-(L,R)
- GBC54-(L,R) GBC60-(L,R)
- GBC60-(L,R) GBC72-(L,R)
- GBC72-(L,R) GBC78-(L,R)
- GBC78-(L,R)
- GBC45-(L,R)

DESIGN CONSIDERATIONS

- Grill base is 28" deep
- Front panel is 12 1/2" high to be cut by installer
- Drawer fronts are 8 3/4" high
- Drawer fronts over 8" can be ordered in a stile and rail configuration for an additional cost

PARTITION

- There is a full depth partition separating the drawers
- The 'R' or 'L' signify what side the drawers are on

Standard Grill Base Cabinets

1 DOOR /
BURNER BASE



SKU

BB15
BB18
BB21
BB24

DESIGN CONSIDERATIONS

- Burner base is 28" deep
- Front panel is 12 1/2" high to be cut by installer
- Sonoma BB24 will have two doors due to weight limitations.

1 DRAWER/
BURNER BASE



SKU

BB15-1D
BB18-1D
BB21-1D
BB24-1D

DESIGN CONSIDERATIONS

- Burner base is 28" deep
- Front panel is 12 1/2" high to be cut by installer
- Drawer front is 17 3/4" high
- Drawer box is 12" H x 20" D
- Drawer fronts over 8" can be ordered in a stile and rail configuration for an additional cost

WARMING
DRAWER
GRILL BASE



SKU

WMDGB30-WMDGB54

DESIGN CONSIDERATIONS

- Standard 28" depth
- Depths available in 3" increments
- Available in 24" depth
- Grill Front is 12-1/2" high
- Bottom Panel is 17-3/4" High
- Reinforced Fixed Shelf
- Two Support Pieces shipped loose
- Full slab front to be cut-out by dealer



Ceramic Grill Cabinets

Sonoma Collection / Avalon Oak



Standard Grill Base Cabinets

WINDSWEPT CERAMIC GRILL CABINETS



SKU

WCG34.5
WCG30.5
DOOR

DESIGN CONSIDERATIONS

- End panels are 30" deep and 3" wide
- For suspended application, see Specialty low base
- Overall H is 34 1/2" or 30 1/2"
- Overall W is 36"

- Inside dimension is 30" wide
- There is a vertical center partition
- A non-combustible surface (stone) must be installed on the resting platform



SKU

WCGD34.5
WCGD30.5
DRAWER

DESIGN CONSIDERATIONS

- End panels are 30" deep and 3" wide
- For suspended application, see Specialty low base
- Overall H is 34 1/2" or 30 1/2"
- Overall W is 36"

- Inside dimension is 30" wide
- There is a vertical center partition
- Drawer box is 10" high
- A non-combustible surface (stone) must be installed on the resting platform

Standard Grill Base Cabinets

SONOMA CERAMIC GRILL CABINETS



SKU

CCG34.5
CCG30.5
DOOR

DESIGN CONSIDERATIONS

- End panels are 30" deep and 5/8" wide
- For suspended application, see Specialty low base
- Overall H is 34 1/2" or 30 1/2"
- Overall W is 36"
- Inside dimension is 34 3/4" wide
- There is a vertical center partition
- A non-combustible surface (stone) must be installed on the resting platform



SKU

CCGD34.5
CCGD30.5
DRAWER

DESIGN CONSIDERATIONS

- End panels are 30" deep and 5/8" wide
- For suspended application, see Specialty low base
- Overall H is 34 1/2" or 30 1/2"
- Overall W is 36"
- Inside dimension is 34 3/4" wide
- There is a vertical center partition
- Drawer box is 10" high
- A non-combustible surface (stone) must be installed on the resting platform

Bow Front Ceramic Grill Cabinets

WINDSWEPT SUSPENDED BOW FRONT

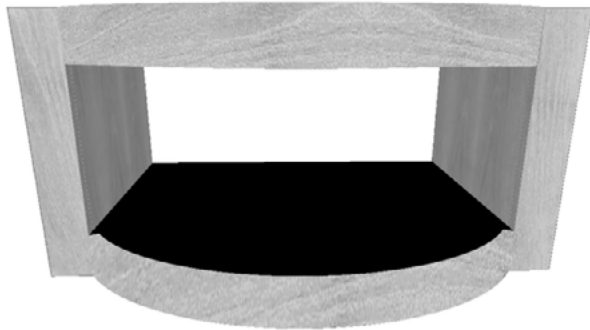

SKU

WSBF-20

DESIGN CONSIDERATIONS

- End panels are 25" deep x 3" wide
- Overall height of suspended cabinet is 20", including 2 3/4" top and bottom rails
- Overall height of free standing unit is 34 1/4"
- Overall width is 36"
- Inside dimension is 30" wide
- Depth to end of radius is 34"
- Radius of arch is approx. 27" outside
- A non-combustible surface (stone) must be installed on the resting platform

WINDSWEPT FREE STANDING BOW FRONT

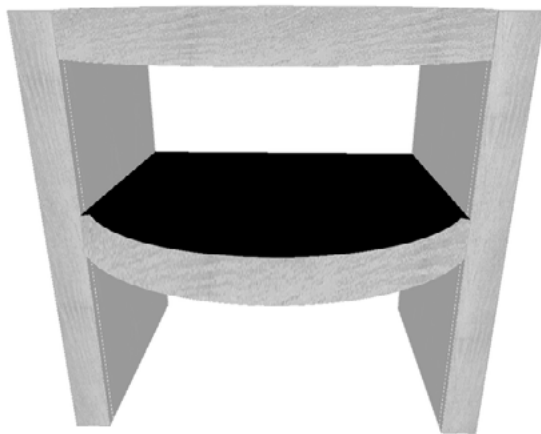

SKU

WFSBF- 34.5



Base Cabinets

Windswept Collection / Storm



Standard Base Cabinet Specifications

All ZählerBuilt boxes are constructed from 3/4" black HDPE panels, making them weather resistant.

- Assembled with Lockdowels
- Full Access, frameless construction
- Standard depth is 24" deep, can be ordered 28" deep.
Drawers remain 21" deep
- 1/4" HDPE thick cabinet backs with 4" nailers top and bottom
- Full depth adjustable shelves
- 110° soft-close stainless steel concealed hinges
- Finished ends can be purchased loose
- Undermount full extension 21" slides, concealed by drawer sides and treated with corrosion blocker
- Drawer boxes are 3/4" HDPE with 1/4" bottoms.
- Standard base cabinets are 30 1/2" H plus an adjustable leg leveler (standard toe kick is 4")

Standard Base Cabinet Specifications

FULL HEIGHT DOOR



SKU

BFH12-BFH21

DESIGN CONSIDERATIONS

- Width available in 1" increments
- 2 adjustable shelves
- Can be order 28" deep
- 'L' or 'R' signifies door hinge location

2 FULL HEIGHT DOORS



SKU

BFH24-2-BFH36-2

DESIGN CONSIDERATIONS

- Width available in 1" increments
- 2 adjustable shelves
- Can be order 28" deep

DRAWER OVER DOOR



SKU

B12-B21

DESIGN CONSIDERATIONS

- Width available in 1" increments
- Top drawer face is 7" high slab
- Drawer box is 4" x 21" deep
- 1 adjustable shelf
- Can be ordered 28" deep, drawer box will remain 21" deep

DRAWER OVER DOORS



SKU

B24-2-B36-2

DESIGN CONSIDERATIONS

- Width available in 1" increments
- Top drawer face is 7" high slab
- Drawer box is 4" x 21" deep 1 adjustable shelf
- Can be ordered 28" deep, drawer box will remain 21" deep

Drawer Base Cabinets

3 DRAWER



SKU

B3D12-36

DESIGN SPECIFICATIONS

- 24" deep cabinet as standard 28" available
- Top drawer face is 7" high slab
- Top drawer box is 4" high
- Drawer Face 2 and 3 are 11 1/2" high
- Drawer Boxes 2 and 3 are 8" high
- Can be ordered 28" deep, drawer box will remain 21" deep
- Drawer fronts over 8" can be ordered in a stile and rail configuration for an additional cost

ROLL OUTS

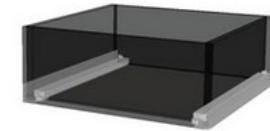

SKU

RO4
RO8

DESIGN SPECIFICATIONS

- 21" deep box
- 4" or 8" deep
- Full extension under mount slides
- Slides are behind front
- 1" spacer on sides

2 DRAWER



SKU

B2D12-36

DESIGN SPECIFICATIONS

- 24" deep cabinet as standard 28" available
- Both Drawer faces are 15" high
- Both drawer boxes are 10" high
- Can be ordered 28" deep, drawer box will remain 21" deep
- Drawer fronts over 8" can be ordered in a stile and rail configuration for an additional cost

Sink Base Cabinets

1 FULL HEIGHT DOOR



SKU

SBFH18 (L,R)
SBFH21 (L,R)

2 FULL HEIGHT DOORS



SKU

SBFH24
SBFH27
SBFH30
SBFH33
SBFH36

DESIGN CONSIDERATIONS

- (L,R) refers to door hinge location
- Width available in 1" increments

SINK SKIRT

- 4" sink skirt including top stretcher

PARTITIONS

- Sink cabinets have no interior partition (unless requested)

SHELVES

- Sink cabinets have no shelves

1 DOOR FALSE FRONT



SKU

SBFF18 (L,R)
SBFF21 (L,R)

2 DOOR FALSE FRONT



SKU

SBFF24
SBFF27
SBFF30
SBFF33
SBFF36

DESIGN CONSIDERATIONS

- (L,R) refers to door hinge location
- Width available in 1" increments

SINK SKIRT

- 8 1/4" sink skirt including top stretcher

PARTITIONS

- Sink cabinets have no interior partition

SHELVES

- Sink cabinets have no shelves
- 7" high slab FF

Specialty Base Cabinets

SPICE PULLOUT



SKU
BSP9

DESIGN CONSIDERATIONS

- Only available 9" wide
- 1 fixed shelf on center
- 2" lip on both sides of fixed shelves

HANGING CUTLERY PULLOUT

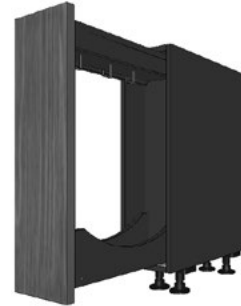

SKU
BGA9

DESIGN CONSIDERATIONS

- Only available 9" wide
- Approx. 26" clear inside height
- 5 stainless steel hanging hooks

LOW HEIGHT BASE DOORS



SKU
LBH24
LBH30
LBH36

DESIGN CONSIDERATIONS

- Cabinet is 12" high plus 4" adjustable legs
- Has a center partition
- Can support a ceramic grill
- Standard is 24" deep

LOW HEIGHT BASE DRAWERS

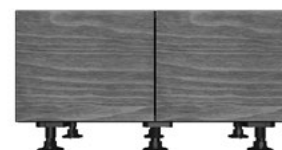

SKU
LHBD24
LHBD30
LHBD36

DESIGN CONSIDERATIONS

- Cabinet is 12" high plus 4" legs
- Drawers are 8" high
- Has a center partition
- Can support a ceramic grill
- Standard is 24" deep
drawer fronts over 8" can be ordered in a stile and rail configuration for an additional cost

Waste Bin Cabinets

FULL HEIGHT WASTE BIN



SKU

FHWB12
FHWB15
FHWB18
FHWB21

DESIGN CONSIDERATIONS

- Trash bin not included. Available as an option.
- Cabinet has a 12" high roll out attached to the front allowing for a 26" high bin
- The 18" and 21" wide will accommodate 2 trash bins

WASTE BIN WITH DRAWER



SKU

BWB12
BWB15
BWB18
BWB21

DESIGN CONSIDERATIONS

- Trash bin not included. Available as an option.
- Drawer front is 7" high
- Cabinet has as 12" high roll out attached to the front allowing for a 18" high bin
- The 18" and 21" wide will accommodate 2 trash bins

Specialty Base Cabinets

WALL DEPTH BASE CABINET 1 DOOR



SKU

WDB12-(12,15,18)
WDB15-(12,15,18)
WDB18-(12,15,18)
WDB21-(12,15,18)

DESIGN CONSIDERATIONS

- Please note 12", 15", or 18" depth
- Cabinet is 30 1/2" high plus 4" levelers
- 2 adjustable shelves

WALL DEPTH BASE CABINET 2 DOOR



SKU

WDB24-(12,15,18)
WDB27-(12,15,18)
WDB30-(12,15,18)
WDB33-(12,15,18)
WDB36-(12,15,18)

DESIGN CONSIDERATIONS

- Please note 12", 15", or 18" depth
- Cabinet is 30 1/2" high plus 4" levelers
- 2 adjustable shelves

Specialty Cabinets

FULL HEIGHT
BLIND CORNER



SKU

BFH42 (L,R)

DESIGN CONSIDERATIONS

- (L,R) refers to door hinge location
- Left side hinge is standard
- 42" W cabinet has a 14 7/8" W door
- Includes a 7" W slab filler where corner cabinet joint perpendicular cabinets
- 1 adjustable shelf

45 DEGREE
CORNER BASE

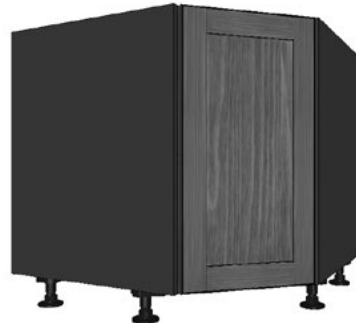

SKU

DCC3636 (L,R)

DESIGN CONSIDERATIONS

- Cabinet is 36" x 36"
- Door is 16" W x 30 1/4" H
- (L,R) refers to door hinge location
- 1 adjustable shelf

GALLEY SINK CAB



SKU

GS48 (L,R)
GS72(L,R)

DESIGN CONSIDERATIONS

- Cabinet is 28" deep
- Top false front is 7" high
- Drawers 2 & 3 are 11 1/2" high
- Specify left or right for drawers
- The side opposite of the drawer is open under for plumbing clearance
- Drawer fronts over 8" can be ordered in a stile and rail configuration for an additional cost

Specialty Cabinets

FARM SINK BASE



SKU

FSSB30-FSSB39

DESIGN CONSIDERATIONS

- Standard 24" depth
- Depths available in 3" increments
- Available in 28" depth.
- Farm Sink False Front is 12-1/2" high.
- Bottom Doors are 17-3/4" High
- Reinforced Fixed Shelf
- Two Support Pieces shipped loose
- Full slab front to be cut-out by dealer.

WARMING DRAWER
BASE 2-DOOR



SKU

WMDB30
WMDB36

DESIGN CONSIDERATIONS

- Standard 24" depth
- Available in 28" depth.
- Warming Drawer Front is 12-1/2" high.
- Bottom Doors are 17-3/4" High
- Partition on center.
- Two Support Pieces shipped loose
- Full slab front to be cut-out by dealer.

MICROWAVE
DRAWER STACK

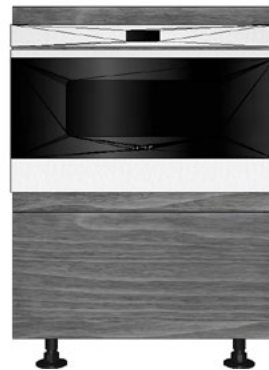

SKU

B2D24-B2D30

DESIGN CONSIDERATIONS

- Standard 24" depth
- Depths available in 1" increments
- Available in 28" depth.
- Microwave Front is 18-5/8" high.
- Bottom Drawer Front is 11-1/2" High
- Full slab Microwave front to be cutout by dealer.



Wall Cabinets

Sonoma Collection / Sea White



Standard Wall Cabinet Specifications

All ZählerBuilt boxes are constructed from 3/4 black HDPE

- Full access, frameless construction
- 1/4" HDPE thick cabinet backs with 4" nailers top and bottom
- Use washers with stainless steel screws when hanging wall cabinets
- Wall cabinets are 13" deep and come with full depth 3/4" thick HDPE adjustable shelves
- Stainless steel, adjustable soft close hinges
- Finished ends, crown and light rails available as accessories
- We recommend a light rail for cabinets over 21" wide
- 11" Clear inside D

Standard Wall Cabinets

1 DOOR CABIN



SKU

18" H
W1218-W2118
(L,R)

SKU

24" H
W1224-W2124 (L,R)

SKU

30" H
W1230-
W2130(L,R)

SKU

36" H
W1236-
W2136(L,R)

DESIGN CONSIDERATIONS

- (L,R) refers to door hinge location
- Width available in 1" increments (13-15,18)

SHELVES

- 18" H - no shelves
- 24" H cabinets - 1 adjustable shelf
- 30" & 36" H cabinets - 2 adjustable shelves
- 13" deep outside, 11" clear inside

2 DOOR CABINET



SKU

18" H
W2418-W3618

SKU

24" H
W2424-W3624

SKU

30" H
W2730-W3630

SKU

36" H
W2436-W3636

DESIGN CONSIDERATIONS

- (L,R) refers to door hinge location
- Width available in 1" increments (13-15,18)

SHELVES

- 18" H - no shelves
- 24" H cabinets - 1 adjustable shelf
- 30" & 36" H cabinets - 2 adjustable shelves
- 13" deep outside, 11" clear inside



Tall Cabinets

Sonoma Collection / Alumina Special Order Color

Tall Cabinets

2-DOOR



SKU

T1294-12(L,R)
T1294-24(L,R)
T1594-12(L,R)
T1594-24(L,R)
T1894-12(L,R)
T2194-12(L,R)
T2194-24(L,R)

4-DOOR



SKU

T2494-12
T2494-24
T2794-12
T2794-24
T3094-12
T3094-24

DESIGN CONSIDERATIONS

- Standard height is 90 1/2" plus 4" levelers
- Top door is always 30" high
- Bottom door will vary with height change
- Fixed shelf between doors

- 6 adjustable shelves total
- Note depth (12" or 24") on order
- Note door swing on 2 door cabinet

An outdoor kitchen island featuring a stainless steel grill with a lid, a sink with a high-arc faucet, and a built-in refrigerator. The island has light-colored wood-grain cabinets and a white countertop. The background shows a stone pillar and a swimming pool.

Panels, Fillers & Accessories

Sonoma Collection / Sea White

Decorative Applied Panels

AP (WIDTH X HEIGHT X STYLE X FINISH)



DESIGN CONSIDERATIONS

- Only available in custom sizes
- Reference the specifications section for additional information and limitations
- Appliance panels, please input the exact size required
- Note door style, color, width and height

End Panels

WINDSWEPT END/ BACK PANEL



SKU

WEP1536
WEP2642
WEP1595
WEP3042
WEP3036
WEP2695
WEP3095

SONOMA END PANEL



SKU

SEP2636
SEP2642
SEP3036
SEP3042
SEP1430
SEP1436
SEP1495
SEP2695
SEP3095

DESIGN CONSIDERATIONS

- All 'end panels' are shipped loose
- All 'end panels' are a slab (not decorative)
- Windswept is 3/4" thick
- Sonoma panels are 5/8" thick
- Standard Sonoma have an ebony edge
- Sonoma can be ordered with a matching front edge (add cost)
- Custom sizes available at additional cost
- Maximum size is 36" x 48" Sonoma
- If size exceeds maximum, need to order a 'back or tall panel'
- Windswept panels are finished on 1 long edge only
- Windswept back panels maximum width is 36" max height is 48"
- Sonoma requires a +/- 1/4" tolerance

Sonoma Box Columns

SONOMA
BOX COLUMN
SHALLOW



SKU

SBCS-3x9X34.5
SBCS-3x9X36
SBCS-3x9X94.5

DESIGN CONSIDERATIONS

- 9 1/4" both sides
- 36" high for scribing as needed
- Matching mitered edge available for an added cost

SONOMA
BOX COLUMN
1 FULL SIDE

Ebony Edge Shown

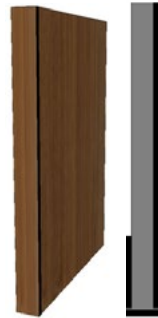

SKU

SBC1S-1.25x2636
SBC1S-2.5x2636
SBC1S-3x2634.5
SBC1S-3x2636
SBC-1S-4x2536
SBC-1S-5x2536
SBC-1S-6x2536
SBC1S-3x2694.5

DESIGN CONSIDERATIONS

- 7 1/4" return 1 side
- 1 side full depth (26" or 30")
- 36" high is for scribing
- Matching mitered edge available for an added cost

SONOMA
BOX COLUMN
3 SIDES

Mitred Edge Shown



SKU

SBC3S-1.25x2636
SBC3S-2.5x2636
SBC3S-3x2634.5
SBC3S-3x2636
SBC3S-4x2636
SBC3S-5x2636
SBC3S-6x2636
SBC3S-3x2694.5

DESIGN CONSIDERATIONS

- Both sides full depth (26" or 30")
- 36" high is for scribing
- Matching mitered edge available
- Custom sizing available at additional cost configuration for an additional cost

Sonoma Box Columns

SONOMA 4-SIDED BOX COLUMN



SKU

- SBC4S-1.25x2536
- SBC4S-2.5x2636
- SBC4S-3x2536
- SBC4S-4x2536
- SBC4S-5x2536
- SBC4S-6x2536

DESIGN CONSIDERATIONS

- 2 full returns and two matching faces
- 25" and 29" deep
- 36" high for scribing
- Matching mitered edge available for an added cost.

SONOMA U-SHAPED BOX COLUMN



SKU

- SBC-U-1.25x2536
- SBC-U-2.5x2536
- SBC-U-3x2536
- SBC-U-4x2536
- SBC-U-5x2536
- SBC-U-6x2536

DESIGN CONSIDERATIONS

- 25" and 29" deep
- 36" high for scribing
- Matching mitered edge available for an added cost.



Windswept Box Columns

WINDSWEPT BOX COLUMN SHALLOW



SKU

WBCS-1.5x9X36
WBCS-2.25x9X36
WBCS-3x9X36
WBCS-3x9X36
WBCS-4x9X36
WBCS-5x9X36
WBCS-3x9X94.5

DESIGN CONSIDERATIONS

- 9" both sides
- 36" high for scribing as needed
- 3" wide

WINDSWEPT BOX COLUMN 1 FULL SIDE



SKU

WBC1S-1.5x2636
WBC1S-2.25x2636
WBC1S3x2634.5
WBC1S3x2636
WBC1S4x2636
WBC1S-5x2636
WBC1S-6x2636
WBC1S-3x2694.5

DESIGN CONSIDERATIONS

- 3" face x 7" one side x full depth 1 side

WINDSWEPT BOX COLUMN 3 SIDES



SKU

WBC3S-1.5x2636
WBC3S-2.25x2636
WBC3S-3x2634.5
WBC3S-3x2636
WBC3S-4x2636
WBC3S-5x2636
WBC3S-6x2636
WBC3S-3x2694.5

DESIGN CONSIDERATIONS

- Finished on 3" w face, side return and long inside edge
- 3" face with both sides finished full depth

Windswept Box Columns

WINDSWEPT 4-SIDED BOX COLUMN



SKU

WBC4S-1.25x2536
WBC4S-2.5x2536
WBC4S-3x2536
WBC4S-4x2536
WBC4S-5x2536
WBC4S-6x2536

DESIGN CONSIDERATIONS

- 2 full returns and two matching faces
- 25" and 29" deep
- 36" high for scribing

WINDSWEPT U-SHAPED BOX COLUMN



SKU

WBC-U-1.25x2536
WBC-U-2.5x2536
WBC-U-3x2536
WBC-U-4x2536
WBC-U-5x2536
WBC-U-6x2536

DESIGN CONSIDERATIONS

- 25" and 29" deep
- 36" high for scribing

Fillers & Floating Shelves

SONOMA FILLER WITH BACKER

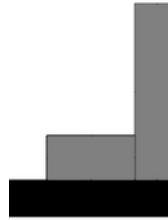

SKU

SF336
SF394.5
SF6536
SF694.5

DESIGN CONSIDERATIONS

- 7" both sides
- 36" high for scribing as needed
- 3" wide

WINDSWEPT FILLER WITH BACKER



SKU

WF336
WF394.5
WF636
WF694.5

DESIGN CONSIDERATIONS

- 3" face x 7" one side x full depth 1 side

WINDSWEPT FLOATING SHELF



SKU

WFS24(L,R,L&R,N) WFS54(L,R,L&R,N)
WFS30(L,R,L&R,N) WFS60(L,R,L&R,N)
WFS36(L,R,L&R,N) WFS66(L,R,L&R,N)
WFS42(L,R,L&R,N) WFS72(L,R,L&R,N)
WFS48(L,R,L&R,N)

DESIGN CONSIDERATIONS

- Finished on 3" w face, side return and long inside edge
- 3" face with both sides finished full depth

(L) Finished Left (L&R) Finished Left & Right
(R) Finished Right (N) Finished None

Corner Fillers

SONOMA
INSIDE CORNER
FILLER

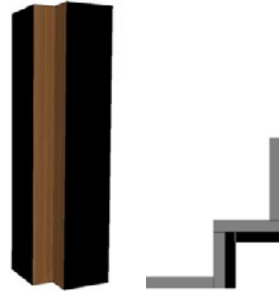

SKU

SICF3x336
SICF6x636

DESIGN CONSIDERATIONS

- 3" x 3" inside filler
- Overall 9 5/8" x 9 5/8" x 36" high
- HDPE back filler

WINDSWEPT
INSIDE CORNER
FILLER

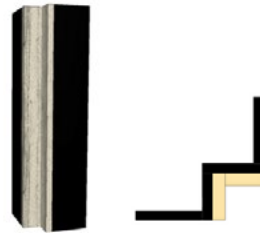

SKU

WICF3x336
WICF6x636

DESIGN CONSIDERATIONS

- 3" x 3" inside filler
- Overall 10" x 10" x 36"
- Matching back filler

APPLIANCE
PILASTER



SKU

APL336
APL636

DESIGN CONSIDERATIONS

- Used to separate under counter appliances and support counter top
- HDPE back structure
- Specify 24" or 28" deep
- Available 3" or 6" wide
- Comes with front that matches door/drawer
- Standard height is 36"



Posts

SONOMA POST 3"

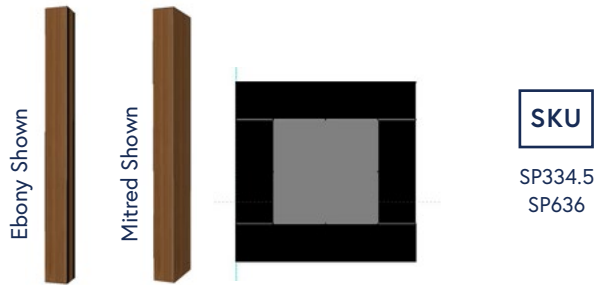

SONOMA POST 6"

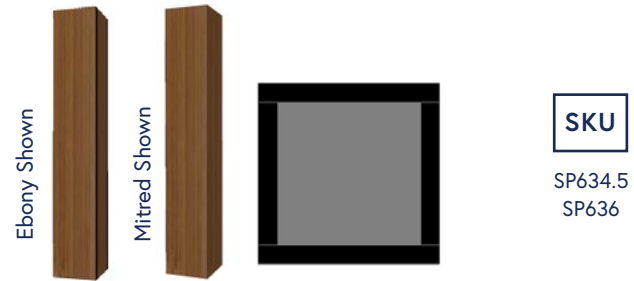

DESIGN CONSIDERATIONS

- We define a post as having 4 finished sides
- Available 34 1/2" or 36" high
- Sonoma standard has 4 ebony edges
- Sonoma can be mitered all sides for additional cost

Posts

WINDSWEPT POST 3"

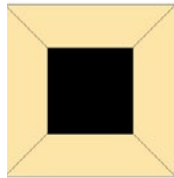

SKU

WP336

WINDSWEPT POST 6"

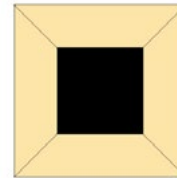

SKU

WP636
Actual Net Size
is 5 1/2" Square

DESIGN CONSIDERATIONS

- We define a post as having 4 finished sides
- 36" high
- 3/4" thick material
- Windswept standard is mitered all sides
- 6" post is 5 1/2" square

HDPE Panels & Toe Plates

BLACK HDPE



SKU

HDPE2424 HDPE3696
HDPE2448 HDPE4448
HDPE2496 HDPE4896
HDPE3648

DESIGN CONSIDERATIONS

- 3/4" thick HDPE
- All edges unfinished

WINDSWEPT TOE PLATE



SKU

WTP

DESIGN CONSIDERATIONS

- 94" maximum standard length
- 5 1/2" standard height
- 5/8" thick
- Windswept primed all sides
- Finished color 1 face

SONOMA TOE PLATE



SKU

STP

DESIGN CONSIDERATIONS

- 94" maximum standard length
- 5 1/2" standard height
- 5/8" thick
- Windswept primed all sides
- Finished color 1 face
- Sonoma has 2 faces, ebony 2 edges

Pulls & Accessories

1" KNOB



SKU
SSK
SSB

7" PULL

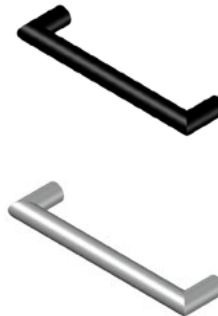

SKU
SSP
SSPB

DESIGN CONSIDERATIONS

- Hardware is 304 stainless Powder coated clear or Black
- ZähBuilt hardware is not drilled or mounted on doors and drawers.

DOOR CAM LOCKS



SKU
CAMLOCK

DESIGN CONSIDERATIONS

- Locks are keyed alike
- Contact your rep for installed lock pricing

TOUCH UP KIT



SKU
TUK

DESIGN CONSIDERATIONS

- Only available in base colors
- Order individually by color

Accessories

LEVELER SPACER



SKU

LS1

DESIGN CONSIDERATIONS

- Adds 3/8" of Height per Spacer
- Can use up to 3

LEVELER INSERT



SKU

LL3
LL7

DESIGN CONSIDERATIONS

- Modifies base cabinet heights from the stock 4" leg
- Standard leg adjusts from 3 3/4" to 5"
- LL3 adjusts from 2 1/2" to 4"
- LS7 adjusts from 6 3/4" to 7 3/4"

LEVELER ADJUSTMENT TOOL



SKU

LAT

DESIGN CONSIDERATIONS

- Used to adjust levelers during install

Dealer Sales Tools

DEALER MINI BASE



SKU

DMB

DESIGN CONSIDERATIONS

- 13" W x 23" H x 13" D + toe
- Specify brushed stainless or black pull
- Color and finish is random, allow 4-6 weeks for requested finished

DEALER SAMPLE DOOR



SKU

DSD

DESIGN CONSIDERATIONS

- Standard sample doors is Windswept White
- 12 3/4" W x 15 3/4" high
- Allow 2 weeks lead time for colors other than white

ZAHBOX (SAMPLES KIT)



SKU

DK

- 4 sample doors (Anvil, Cumulus, Virga, and Stratus)
- 1 set of blocks of both Windswept and Sonoma Collections
- Sample Block Holders.
- Colors on the door samples are predetermined and not selectable
- Cirrus and Neo doors not included must be ordered separately

SONOMA SAMPLE BLOCKS



SKU

CSB

DESIGN CONSIDERATIONS

- 6" x 6" x 5/8" thick blocks
- Includes stand

WINDSWEPT SAMPLE BLOCKS



SKU

WSB

DESIGN CONSIDERATIONS

- 6 blocks 2 3/4" W x 6" long
- Finished 1 edge 1 face



Windswept Moldings



ACCOYA®

A new way of thinking about wood



PERFORMANCE

Excels in every way



WARRANTY



HIGHLY STABLE



HIGHLY DURABLE

FINISH

Beautifully versatile



IDEAL FOR COATING



LOW MAINTENANCE



NATURAL WOOD

SUSTAINABILITY

World-changing environmental credentials



SUSTAINABLY SOURCED



NON TOXIC



100% RECYCLABLE

Accoya turns everything you know about wood on its head. Through a revolutionary process called acetylation, it modifies wood to give it properties above and beyond the very best hardwoods - and in many cases, aluminum and PVC.

Highly durable and stable, Accoya withstands the test of any climate.

The warranty is a testament to the fact you will enjoy your Accoya wood for years to come.



To learn more visit:

[ACCOYA.COM](https://www.accoya.com)



Copyright © Accsys Technologies 2024. Accsys Technologies is a trading name of Titan Wood Limited. Accoya® and the Trimarque Device are registered trademarks owned by Titan Wood Limited and may not be used or reproduced without written permission.

Windswept Crown

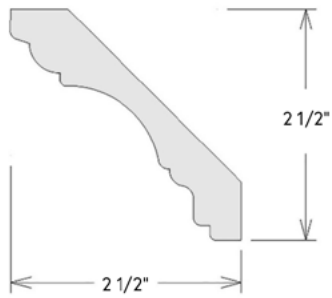

SKU

WSC71
Net width is 3 1/2"W

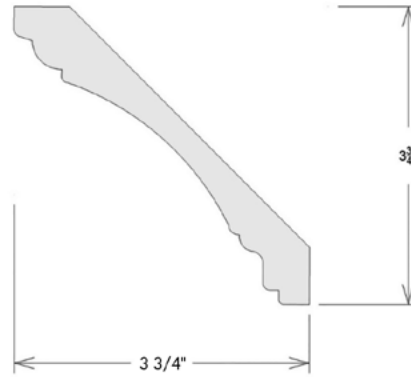

SKU

WSC50
Net width is 5 1/4" W

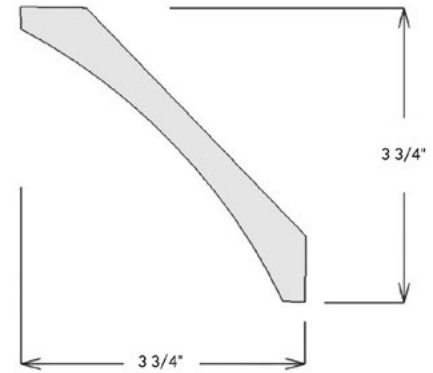

SKU

WSC103
Net width is 5 1/4" W

DESIGN CONSIDERATIONS

- If a nailer is needed please order
- Flat Stock or Base
- 94" maximum standard length
- Primed all sides
- Finished color on all exposed faces

Windswept Crown

ZAH DOOR LOUVER

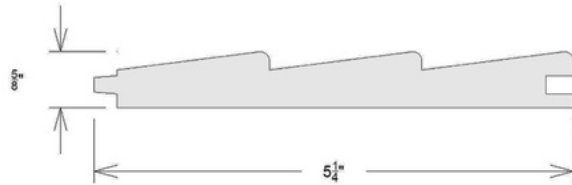

SKU

WSZL

NICKLE JOINT

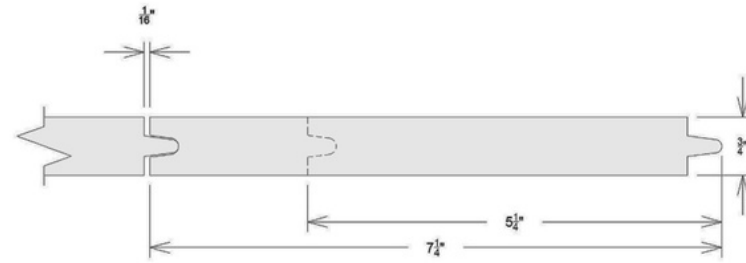

SKU

WSNJ5.25
WSNJ7.25

"V" JOINT MISC 007
(5 1/4" & 7 1/4")

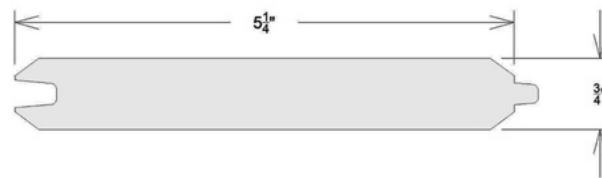

SKU

WSVJ

DESIGN CONSIDERATIONS

- 94" maximum standard length
- Primed all sides
- Finished color on all exposed faces



Windswept Base Boards

PROFILE BASE



SKU

BP192.25
BP195.25
BP197.25

BEVELED BASE



SKU

BB3.25
BB5.25
BB7.25

DOOR PROFILE BASE

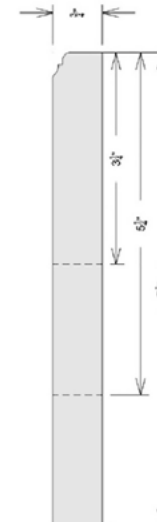

SKU

BDP3.25
BDP5.25
BDP7.25

DESIGN CONSIDERATIONS

- 94" maximum standard length
- Primed all sides
- Finished color on all exposed faces



Misc. Windswept Moldings

PICTURE FRAME MOLDING

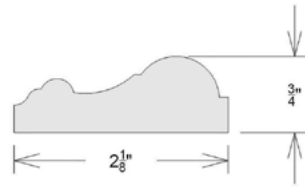

SKU

M095

DESIGN CONSIDERATIONS

- 94" maximum standard length

VALANCE

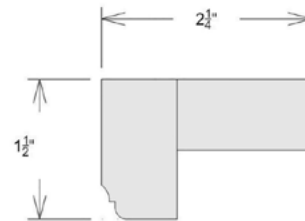

SKU

WSV
CV

DESIGN CONSIDERATIONS

- 94" maximum standard length
- Primed all sides
- Finished color on 1 face and profiled edge

FLAT STOCK

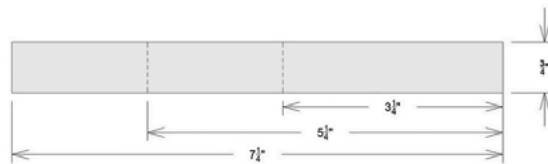

SKU

1x4x8
1x6x8
1x8x8

DESIGN CONSIDERATIONS

- Net size of 1x4x8 is 3/4" x 3 1/4" x 94"
- Net size of 1x6x8 is 3/4" x 5 1/4" x 94"
- Net size of 1x8x8 is 3/4" x 7 1/4" x 94"
- Flat stock is primed all sides Finished
- Color on 1 face and 1 edge
- Additional Finished faces and edges at added cost





Hoods

Windswept Louver Hood

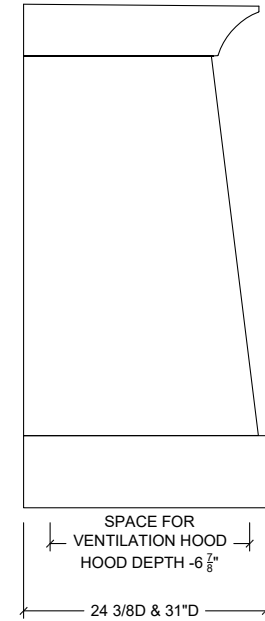
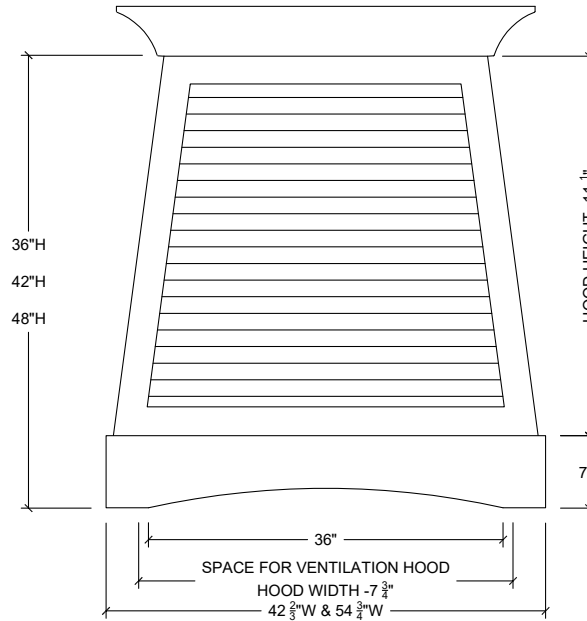

DESIGN CONSIDERATIONS

- Widths available 44" and 55"
- Heights available 36", 42" and 48"
- Depths available 25" and 32"
- Crown molding is shipped loose and is optional
- Ventilator cut out is done on site
- Generally liner must be 36" above cooking surface

SKU

LH4436-25	LH5536-25
LH4436-32	LH5536-32
LH4442-25	LH5542-25
LH4442-32	LH5542-32
LH4448-25	LH5548-25
LH4448-32	LH5548-32

Windswept Shaker Hood

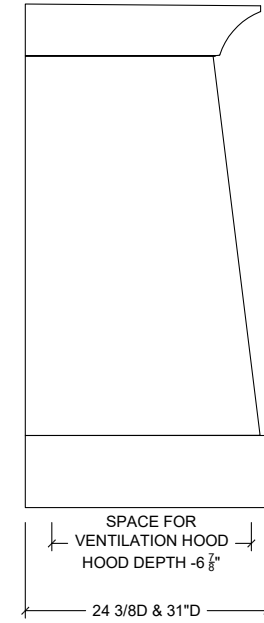
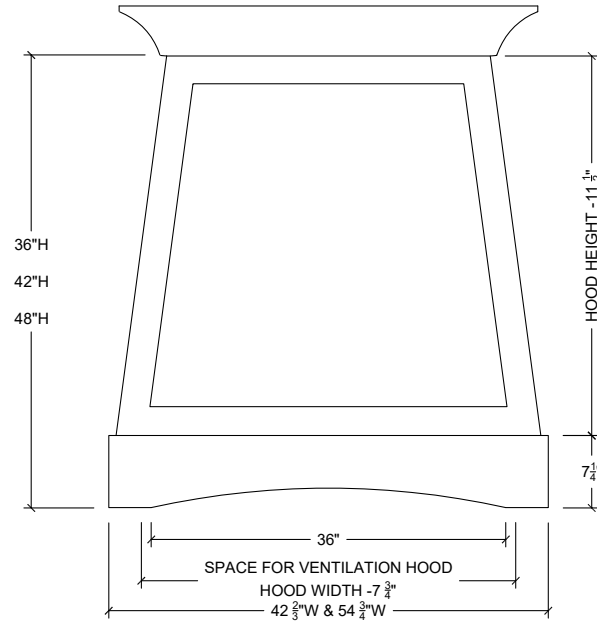

DESIGN CONSIDERATIONS

- Widths available 44" and 55"
- Heights available 36", 42" and 48"
- Depths available 25" and 32"
- Crown molding is shipped loose and is optional
- Ventilator cut out is done on site
- Generally liner must be 36" above cooking surface

SKU

SH4436-25	SH5536-25
SH4436-32	SH5536-32
SH4442-25	SH5542-25
SH4442-32	SH5542-32
SH4448-25	SH5548-25
SH4448-32	SH5548-32

Windswept Nickel Joint Hood

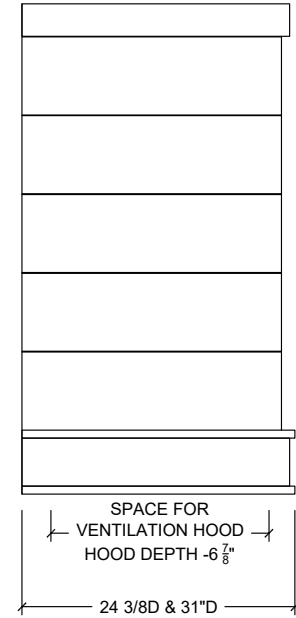
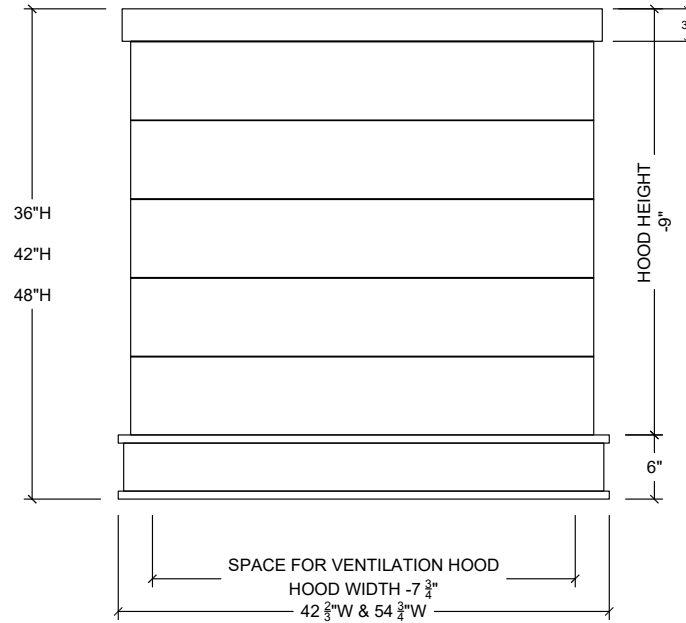

DESIGN CONSIDERATIONS

- Widths available 44" and 55"
- Heights available 36", 42" and 48"
- Depths available 25" and 32"
- Crown molding is shipped loose and is optional
- Ventilator cut out is done on site
- Generally liner must be 36" above cooking surface

SKU

NJH4436-25 NJH5536-25
 NJH4436-32 NJH5536-32
 NJH4442-25 NJH5542-25
 NJH4442-32 NJH5542-32
 NJH4448-25 NJH5548-25
 NJH4448-32 NJH5548-32



Sonoma Collection / Royal Walnut



ZÄHBUILT

Reimagining The Way We Live

☎ 321-308-3297 ✉ SALES@ZAHBUILT.COM 📍 325 EAST DRIVE, MELBOURNE, FL 32904 ZAHBUILT.COM

